

Soil monitoring technologies on Internet of Things

Pužin, Miha

Master's thesis / Diplomski rad

2020

Degree Grantor / Ustanova koja je dodijelila akademski / stručni stupanj: **University of Zagreb, Faculty of Agriculture / Sveučilište u Zagrebu, Agronomski fakultet**

Permanent link / Trajna poveznica: <https://um.nsk.hr/um:nbn:hr:204:848186>

Rights / Prava: [In copyright](#)/[Zaštićeno autorskim pravom.](#)

Download date / Datum preuzimanja: **2025-01-26**



Repository / Repozitorij:

[Repository Faculty of Agriculture University of Zagreb](#)





Sveučilište u Zagrebu
Agronomski fakultet

University of Zagreb
Faculty of Agriculture



Soil Monitoring technologies based on Internet of Things

MASTER'S THESIS

Miha Pužin

Zagreb, September, 2020.



Sveučilište u Zagrebu
Agronomski fakultet

University of Zagreb
Faculty of Agriculture



Graduate study programme:

Environment, agriculture and resource management (INTER-EnAgro)

Soil Monitoring technologies based on Internet of Things

MASTER'S THESIS

Miha Pužin

Mentor:

Assis. Prof. Monika Zovko PhD

Zagreb, September, 2020.



Sveučilište u Zagrebu
Agronomski fakultet

University of Zagreb
Faculty of Agriculture



STUDENT'S STATEMENT ON ACADEMIC RECTITUDE

I, **Miha Pužin** JMBAG 0178097378, born on 24 January 1994 in Zagreb, declare that I have independently written the thesis under the title of

Soil Monitoring technologies based on Internet of Things

With my signature, I guarantee:

- that I am the only author of this thesis;
- that all literature references, published or unpublished, are adequately cited or paraphrased, and listed at the end of this paper;
- that this thesis does not contain parts of other papers submitted at the Faculty of Agriculture or other higher education institutes, for the reason of completing studies;
- that electronic version of this thesis is identical to the printed one approved by the mentor;
- That I am familiar with regulative of the Ethical Code of Students of the University of Zagreb (Art. 19).

In Zagreb, date _____

Student's signature



Sveučilište u Zagrebu
Agronomski fakultet

University of Zagreb
Faculty of Agriculture



REPORT

ON EVALUATION AND MASTER'S THESIS DEFENSE

Master's thesis written by **Miha Pužin**, JMBAG 0178097378, under the title of
Soil monitoring technologies based on Internet of Things

Is defended and evaluated with the grade _____, on _____.

Committee for thesis evaluation and defense:

signatures:

1. Assistant Professor Monika Zovko PhD, mentor _____.
2. Associate Professor Ivana Šestak PhD, Committee member _____.
3. Assoc.Prof. Marina Bačić Babac, PhD Committee member _____.

Table of Contents

1	Introduction	1
1.1	Aims of the thesis.....	2
2	Literature review	3
2.1	Optical sensing methods for assessment of soil macronutrients.....	3
2.2	Visible light-sensing methods	5
2.2.1	Colorimetry	7
2.3	Near-infrared and infrared sensing methods	10
2.3.1	Raman spectroscopy	14
2.3.2	Fourier Transform Infrared (FTIR) spectroscopy.....	15
3	Electrochemical sensing methods.....	18
3.1	Ion-selective field-effect transistors (ISFET).....	18
3.2	Ion-selective electrodes (ISE)	20
4	Internet of Things applications in real-time soil monitoring.....	22
4.1	IoT in digital farming.....	25
4.2	Artificial Intelligence (AI) applications in soil monitoring.....	27
5	General overview of soil monitoring technologies	29
6	Conclusion	30
7	References.....	31

Summary

Of the master's thesis written by Miha Pužin, under the title of:

Soil monitoring technologies based on Internet of Things

This thesis will present an Internet of Things based complex system of embedded technologies consisting of sensors, microprocessors, and wireless communications integrated with either optical or electrochemical sensors that can collect and deliver real-time quality soil information data. Emphasis will be placed on technologies requiring minimum sample preparation, little to no maintenance, infrequent calibration and have short and accurate sampling time.

Keywords: soil macronutrients, soil sensing technologies, Internet of Things

1 Introduction

Soil is a fundamental natural resource for human civilization. It is an integral part of terrestrial ecosystems that provides a multitude of goods and services in terms of food, fibre and energy production, supporting and regulating life on the planet. The continuous growth of the population leads to an increasing demand for food production worldwide. To keep up with the trend over the past seven decades, farmers have relied on intensive agricultural practices that have led to soil degradation. In the next thirty years, Earth's population will reach approximately 9 billion, and will require an increase in food production by more than 70 percent (Sinfield et al. 2010.). Agriculture is facing a number of challenges such as food security, climate change, water scarcity, and environmental degradation in the years to come, thus making preservation and sustainable management of soils a crucial priority in tackling these challenges. The rising utilization of food crops for various industries (bioenergy, biofuel) is further increasing the pressure on a scarce agricultural resource as well as poses a serious threat to the availability of arable land. Preceding solar minimum brings about many changes in the atmosphere that will lead to dramatic shifts in weather conditions globally. However, recent technical advances in electronics, digital signal processing, and miniaturization of sensing hardware provide an opportunity to tackle a number of future challenges.

Agriculture has undergone a great transformation during the last few decades shifting production from small/medium farmers to highly specialized and commercial farming operations. With the rise of Industry 4.0, development of wireless communication, cloud computing, machine learning and Big Data technologies, Internet of Things technology is gradually being applied in a wide range of agricultural uses. The emerging agri-tech revolution aims to use advanced precision technology, such as real-time soil nutrient sensors and Internet of Things (IoT), to meet the future demands for food, fibre, and fuel, in a more sustainable, efficient, and eco-friendly manner. Advanced information technologies allow faster and stable transmission of sensor data and are becoming more affordable due to the miniaturization of hardware and lower material costs. Implementation of IoT in agriculture can help create an informed, connected, developed, and adaptable rural community. Low-cost embedded devices can improve the interaction between humans and the physical world. Given that soil, productivity has spatial and temporal variability influenced by intrinsic (parent material, climate, topography) and extrinsic (farm management practices) factors, a

site-specific management system that continuously collects and processes soil information data can efficiently optimize farm inputs through data-driven decision making. Precision agriculture is a data demanding system that incorporates intelligent sensing systems, cloud computing, edge computing into a single platform. Soil is a dynamic complex matrix consisting of organic and inorganic mineral fractions, water, and air. The three most essential soil macronutrients that play a fundamental role in the balanced soil system formation are nitrogen, phosphorus, and potassium (N, P, K). These macronutrients are essential for soil stability and fertility and play an important role in healthy plant growth. The monitoring of these nutrient levels in soils provides useful information on actual soil conditions, moreover, information obtained in real-time can permit design-intelligent soil mapping, irrigation, and fertilization management systems (Lvova and Nadporozhskaya 2017.).

1.1 Aims of the thesis

Current soil chemical characteristics (e.g. macronutrients, pH, salinity) assessment and monitoring technologies will be reviewed in-depth and categorized by sensing technology (e.g., chemical, electrical, optical). Although there has been a significant rise in the development of precision agriculture technologies to continuously monitor pH, salinity, moisture content and organic matter in situ measurement of soil macronutrients, nitrogen (N), phosphorus (P) and potassium (K) still remains a challenge.

2 Literature review

2.1 Optical sensing methods for assessment of soil macronutrients

Optical sensors rely on changes in the various light properties (photon radiation intensity) to detect analyte of interest. Light intensity can be modulated by absorption, or the direction of wave propagation or wavelength can be modulated by scattering, refraction, or reflection (Lvova and Nadporozhskaya 2017.). Optical chemical sensors can use visible and near-infrared wavelengths to measure and identify the magnitude of reflected, absorbed, and transmitted energy of soil nutrient ions. Due to the principles of energy-matter interactions, a material can reflect, absorb, scatter, and emit electromagnetic radiation in a characteristic manner that depends on its molecular composition and shape, resulting in a unique spectral signature (Shaw et al. 2003.). The hardware consists of a light source (usually light-emitting diode) or laser sent through the optic fibre to the tip of deposited sensing film. Certain constituents in the soil interact and absorb electromagnetic energy, which leads to their quantification (Ge et al. 2019.).

Soil nutrients, such as Nitrogen (N), Phosphorus (P), and Potassium (K), can be determined using a number of approaches based on principles of energy-matter interactions. A material can reflect, absorb, scatter, and emit electromagnetic radiation in a characteristic manner that depends on its molecular composition and shape, resulting in a unique spectral signature. Over the past three decades, optical sensing approaches are being thoroughly investigated and studied by many research institutes, universities and commercial companies worldwide, mainly due to their attractive advantages over electrochemical technology and non-destructive sampling nature.

There are many reasons for the interest in newer soil measurement technologies. For example, sample preparation involves only drying and crushing, the sample is not affected by the analysis in any way, no (hazardous) chemicals are required, measurement takes a few seconds, several soil properties can be estimated from a single scan, and the technique can be used both in the laboratory and in situ (Viscarra Rossel et al. 2006.). Since the 1990s, several soil sensing instruments for on-site measurements have been developed (Adamchuk et al.

2002., 2004., 2005., Christy 2008., Li et al. 2010., Shibusawa 2003., Shonk et al. 1991., Sudduth and Hummel 1993.).

The approach to each measuring technique can be categorized based on response time and sensitivity, and the nature of the sample to be analysed. Measurement approaches include direct soil measurement (DSM), soil solution measurement (SSM), chemical extract measurement (CEM), filtered solution measurement (FSM), and agitated soil measurement (ASM). The following chapter provides a basic description of different approaches to proximal soil sensing including applications of colorimetric methods, visible near-infrared, and shortwave infrared (VNIR-SWIR) spectroscopy and mid-infrared (MIR) spectroscopy.

High spatial and temporal variability of soil physical and chemical properties represents the main obstacle for the application of the precision agriculture concept. The standard methods of soil analysis include first, classical wet chemistry methods, and various instrumental methods, such as molecular emission spectrometry, atomic absorption spectrometry (AAS), nuclear magnetic resonance spectroscopy, high-performance liquid chromatography (HPLC), and gas chromatography (GC) combined with mass spectrometry (MS). These methods are often complex due to the extraction and pre-treatment processes involved; they are time- and effort-consuming and require sophisticated and often expensive equipment and qualified personnel involvement (Lvova and Nadporozhskaya 2017.).

Lately, the involvement of familiar optical devices (digital and web-camera) and image interpretation (often based on colour differences) has been intensely utilized for different monitoring purposes, and soil analysis in particular (Motellier et al. 1995., Hung et al. 2010., Viscarra Rossel et al. 2008., Yokota et al. 2007.). Recent advancements in IoT, and the emergence of micro-electro-mechanical sensor systems (MEMS) have the potential to meet the requirements of modern soil management concept. In MEMS-based devices all the optical and mechanical components are integrated on a single MEMS chip, offering the ability for in-field soil analysis using handheld spectral sensing.

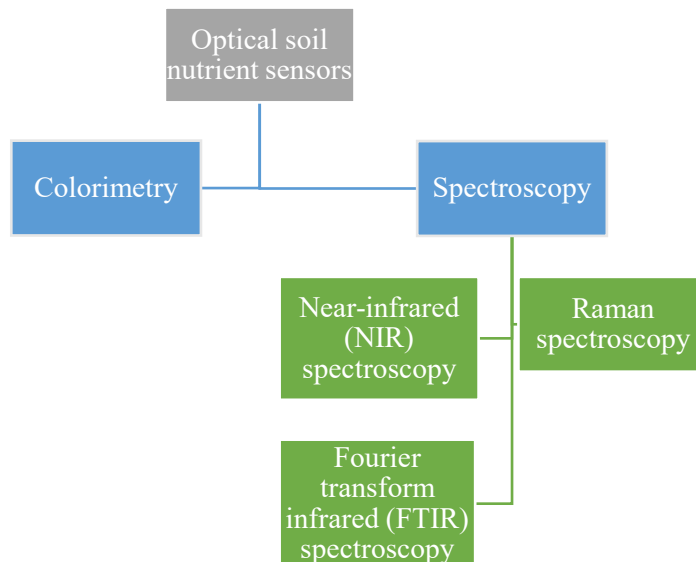

Figure 2.1. Flowchart depicting optical soil assessment methods (Adapted from Burton et al. 2020.)

2.2 Visible light-sensing methods

The electromagnetic (EM) spectrum (Figure 2.2.) ranges from gamma (γ) rays, at the shortest wavelengths, to radio-waves, at the longest wavelengths. Visible light covers only a small portion of the electromagnetic spectrum between infrared (IR) and ultraviolet (UV) wavelengths in the range of about 380 nanometres (nm) to 740 nm (Figure 2.3.). The most common methods used to detect and measure soil nutrients can include traditional laboratory-based methods (Kjeldahl wet digestion, dumas combustion, and gas chromatography and mass spectrometry), optical methods (colorimetry based technique, IR spectroscopy), and electrochemical methods (ion-selective electrodes, ion-selective field-effect transistors).

Colorimetric methods are used to determine the concentration of dissolved species, relying on the ability of many ionic species to absorb light of one or more specific wavelengths following the Beer-Lambert law. Colorimetric based sensor systems are simple photometric sensors consisting of a light (radiation) source and a light detector (photodiode). Photoelectric sensors convert the light intensity to an electrical current signal. Current signal changes with changes in light intensity caused by the changes of colour intensity of the solution.

Wavelengths in the visible, near-infrared, and mid-infrared ranges can also be used to determine the chemical, physical, and mineralogical composition of the soil. In recent decades, spectroscopy has proven to be an effective tool in terms of soil science. The use of spectroscopy for soil analyses is a fast, inexpensive, environmental/friendly, non-destructive, and precise technique for assessment. Soil spectroscopy is slowly gaining traction in scientific research, as spectrometers have become miniaturized, rugged, and cheap making them perfect for in-field use. The fundamental principle of VisNIR reflectance spectroscopy is based on the differences in molecular characteristics, where spectral signatures of different materials are categorized based on their reflectance and absorbance spectra. The change in signatures is referred to as vibrational extending and bending of atoms that arrange molecules and crystals. Most soil components are usually observed in the midinfrared region vibrations (2500–25,000 nm), with overtones and combinations found in the near-infrared region (400–2500 nm) (Clark 1999., Shepherd and Walsh 2002.). The following chapter provides a fundamental description of colorimetric methods, visible near-infrared, and shortwave infrared (VNIR-SWIR) and MIR spectroscopy applications in soil analysis.

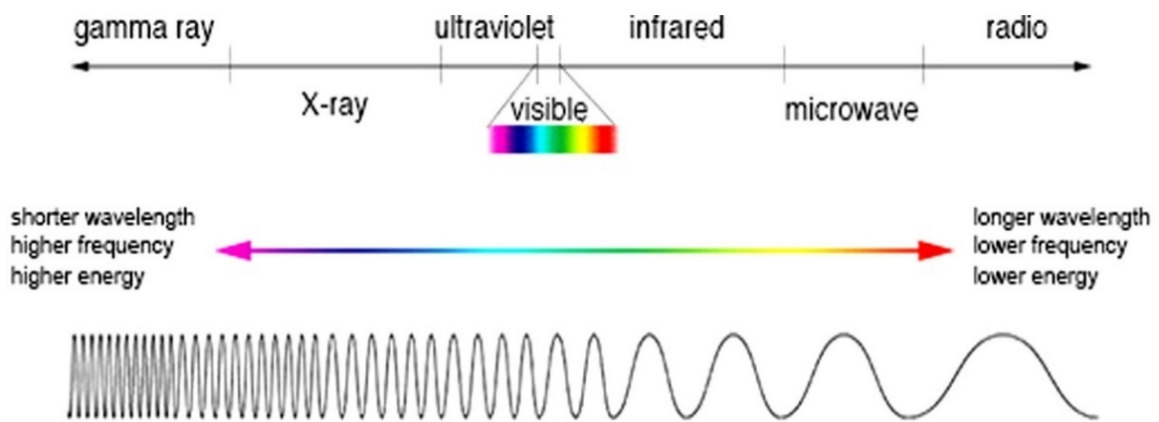

Figure 2.2. Electromagnetic spectrum (source: [NASA](#), 2004.)

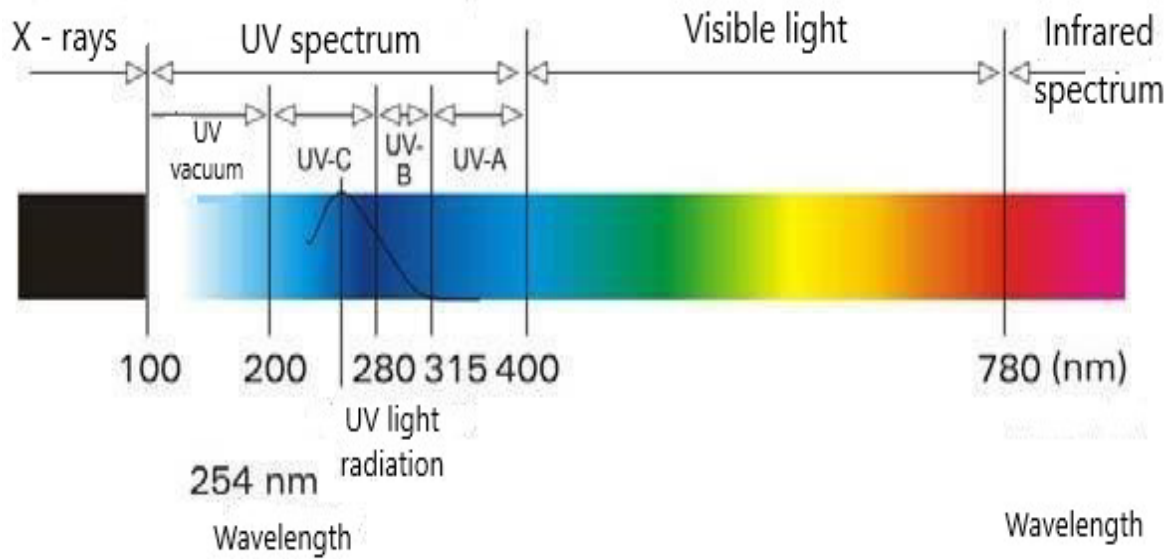

Figure 2.3. Distribution of wavelengths in UV – Visible – Near-infrared regions (Source: Čoga, 2019.)

2.2.1 Colorimetry

Colorimetry is a scientific technique that is used to determine the concentration of coloured compounds in solutions by the application of the Beer-Lambert law. Soil sensors using colorimetric methods employ detection mechanisms based on Beer-Lambert law which relates attenuation theory of light to the properties of the material through which the light beam is traveling. Beer-Lambert Law relates the absorbance of the sample with the concentration of the solution, in other words, Beer-Lambert Law states that absorbance is proportional to the concentration of the sample and proportional to the path of light beam passing through the sample. The soil sample is mixed with chemical reagents in order to initiate a chemical reaction with nutrients in the soil. Sample develops colour changes ranging in intensity that is depended on the amount of present nutrients (concentration) detected by sensor. A colorimetric measurement of mixed soil solution works on the principle of colour absorption by soil sample and is given by:

$$A = -\log_{10} \left(\frac{I}{I_0} \right) = \log_{10} \frac{1}{T} = \varepsilon \cdot L \cdot C \quad (1)$$

$$T = \frac{I}{I_0} \quad (2)$$

Where A is the absorbance of the sample (absorbance units), I_0 is the intensity of incident (initial) light beam entering the sample, I is the intensity of light beam after passing through

the sample, ϵ is molar absorptivity ($L \text{ mol}^{-1} \text{ cm}^{-1}$), L is path length (cm), C is the concentration of the absorbing chemical species (mol L^{-1}), T denotes the transmittance of the sample.

A simplified depiction showing the principle of Beer-Lambert law application in colorimetric measurements is illustrated in Figure 2.4.

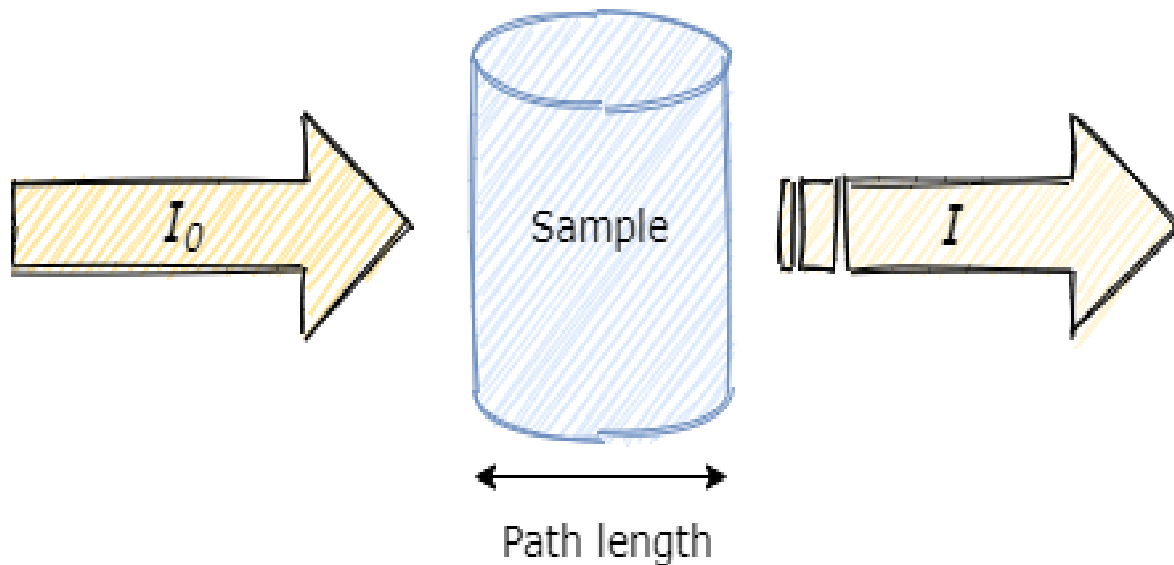

Figure 2.4 Illustration of light absorption by a sample when a beam passes through it (Adapted from Khairunnisa, 2016.)

Notable research related to colorimetric soil nutrient analysis has been done so far. The method has been successfully applied both commercially and scientifically. The available literature on the use of soil colorimetry methods provides basic information about the technique but is inconsistent in methodology with highly variable results making replication difficult. A beam of light with known optical properties, for example, frequency, wavelength, and/or amplitude, can be transmitted through the solution and analysed after passing through the sample. The altered optical property of the light beam can be used to determine a corresponding chemical property of the soil in the solution. Regalado and Dela Cruz (2016.) integrated soil sensing device with IoT, demonstrating the possibility to perform analysis remotely. Kumar et al. (2019.) developed soil NPK testing system consisting of testing chemicals, colour sensors, soil moisture sensor, temperature sensor, GPS, and an android application that sends reports to the user and provides site-specific fertilizer recommendation based on soil test results. Further research into technique by Lau et.al (2004.) Yokota et al. (2007.), Khairunnisa (2016.) and Chowdhury (2016.) has shown the effectiveness and high feasibility of soil colorimetric methods by developing sensing devices constructed using inexpensive hardware such as LEDs and MEMS integrated photodiodes. Yokota et al. (2007.) have designed an optical sensor based

on photometric detection of soil nutrients: ammonia nitrogen ($\text{NH}_4\text{-N}$), nitrate-nitrogen (NO_3^- N), available phosphorus (P_2O_5). The LEDs light source of the wavelength that fits the absorption band of chemical reagents. whose colour develops by reaction with soil nutrients. Ramane et al. (2015.) developed a fibre optic-based NPK colour sensor. The colour sensor determines NPK values from the soil sample by colorimetric measurement of an aqueous solution of soil. The determined NPK amounts are expressed as high, medium, low, or none. A similar but more complex soil analysis system was developed by More et al. (2019.). The paper proposed a soil analysis system using IoT in order to provide farmers with proper fertilizer recommendations via a web application. Recommendations were based on the soil test results and suggested only organic fertilizers to help farmers improve soil health and achieve fertility in long run. Commercially available digital soil testing device (1605 Rapitest Digital Soil Test kit) was introduced by the United States-based company Luster Leaf. Digital soil testing device (Figure 2.5.) measures nitrogen as nitrate (NO_3^-), phosphorus as P_2O_5 , and potassium as K_2O using the colorimetric method. The digital soil test kit uses a bi-colour LED as a light source for detecting the passage of light from the solution of soil extract and reagent taken in a test tube. For the NO_3^- test, the green light of 565 nm wavelength is used while the red light of 633 nm is used in the determination of P_2O_5 and K_2O . Rapitest kit is a fast and economic means by which farmers and agricultural service personnel can improve nutrient management for crop production and environmental protection.

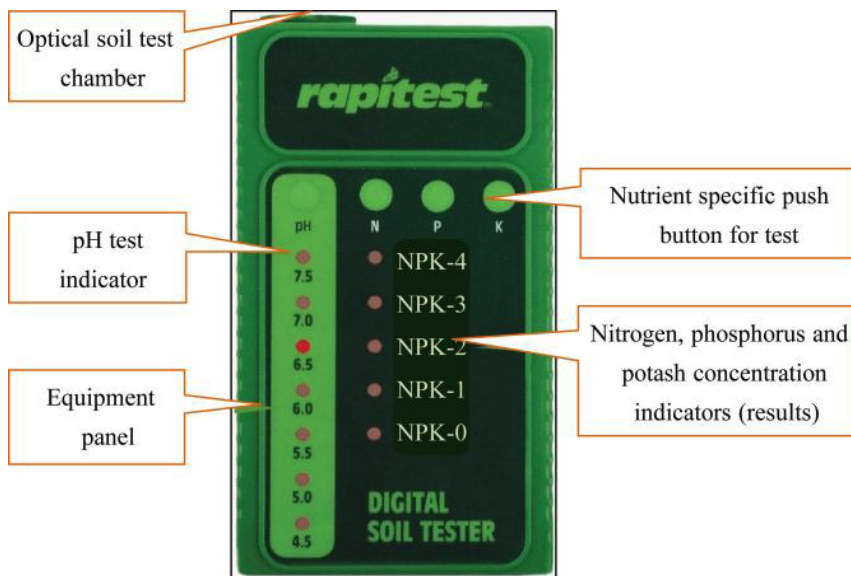

Figure 2.5. Luster Leaf Rapitest 1605 digital soil testing device (Source: http://www.lusterleaf.com/nav/soil_test.html)

Recent advancements in the digital technology realm have led to the possibility of integrating mobile colorimetric soil nutrient testing with digital application systems such as Android operating systems, using smartphones. A paper by Moonrungsee et al. (2015.) explored the use of Android smartphone and mobile camera colorimetric analyser to detect P in soil.

Colorimetry can be used to analyse soil nutrients but not without commercially available chemical test kits. When integrated with IoT, colorimetry offers an affordable and reliable option of soil analysis and monitoring. On a general basis, colorimetry-based methods require sample preparation steps, including mixing the extraction solutions of specific nutrients with a specific quantity of soil. Accuracy of results is highly dependent on the type of chemical reagent used, therefore this method isn't currently appropriate for use in precision fertilization schemes. To achieve the full potential of colorimetry-based methods, much more research is required. The colorimetric method can be a good alternate for an inexpensive and quick on-the-spot analysis of soil for NPK and may give a good estimation of NPK in accordance with the laboratory method (Yamin et al. 2019.).

2.3 Near-infrared and infrared sensing methods

Infrared (IR) radiation covers wavelength ranges between 780 nm and 1000 μm . Infrared spectroscopy is based on the interaction of molecules with electromagnetic energy (Raphael 2011.). The basic principle of infrared spectroscopy is based on the fundamental vibrations of the molecules. IR radiation will activate molecular interatomic vibrations, and this provides the basis of the IR spectroscopy technique. Each molecule has certain natural vibrational frequencies. When infrared light is incident on the molecule, the frequency which matches the natural vibrational frequency is absorbed by the molecule resulting in molecular vibrations. Consequently, a change in the dipole moment of the molecule occurs. There are many types of molecular vibrations that occur on the absorption of IR radiation including stretching, bending, and wagging of the constituent atoms in the molecule. IR spectroscopy in the MIR range is also called FTIR (Fourier transform infrared) spectroscopy, this term closely describes how MIR instruments work. For a compound to be IR active, it is required to have covalent bonding. Infrared spectroscopy, both near-infrared (NIR) and mid-infrared (MIR)

methods, enable rapid acquisition of detailed soil information data and estimation of various physical, chemical, and biological soil properties.

To date, most studies have used either visible near-infrared (VNIR) or MIR spectroscopy in a study-specific context (Sanderman et al. 2020.). Near-infrared spectroscopy uses EM spectrum ranges from 780 nm to 2500 nm and is the most commonly used optical sensing method to detect soil nutrients (and other soil constituents). Even though there are many advantages of near-infrared spectroscopy when compared to conventional soil analysis methods, it is worthwhile mentioning that many VNIR instruments do not provide quantitative results of soil properties directly. To acquire proper results that relate captured spectral data to analysed soil properties, researchers have developed calibration methods for model training, also referred to as chemometrics methods. Calibration methods can be classified into linear regression techniques and data mining techniques. Techniques for model training based on linear regression include stepwise multiple linear regression (SMLR), principal component regression (PCR), and partial least squares regression (PLSR). Data mining techniques train models with the help of artificial intelligence and include multivariate adaptive regression splines (MARS), boosted regression trees, and artificial neural networks (ANN).

Near-infrared spectroscopy can quantify light energy absorbed and, or diffusely reflected by soil sample interrogated with the polychromatic light radiation source. The basic underlying principle of NIR spectroscopy (NIRS) is based on the theory of simple harmonic oscillations. Shared chemical bonds between two atoms are an example of a simple harmonic oscillator system. These bonds have resonant characteristics depending on the atomic weight at the end of each bond and the „spring” constant which describes the force between them. As seen in Figure 4, when a sample is irradiated with a band of frequencies, those frequencies that correspond to vibrational frequencies of the bonds in the sample become absorbed while other frequencies are reflected (or transmitted). The near-infrared spectroscopy (NIRS) analytical method is an available tool to estimate the content of components in an organic substance quickly (Zhang et al. 1992, Ben-Dor and Banin 1995, Li et al. 2006, Viscarra Rossel et al. 2006). The diffused reflectance from the sample is recorded with a spectrophotometer, forming a reflectance spectrum which indicates the intensity of light captured as a function of wavelength. The ability of NIR reflectance spectroscopy to provide a field-scale assessment of soil properties in terms of variable mineral nitrogen fertilization was researched in a paper by Šestak et al. (2018.). Results revealed delineation between high and low N treatments which were conditioned by differences in soil pH, texture, and soil organic matter composition. The

model obtained by principal component explanatory analysis and partial least square regression indicated the effectiveness of Vis-NIR spectroscopy for measuring soil functional attributes. NIRS based instruments use MEMS or LED's as sources of light.

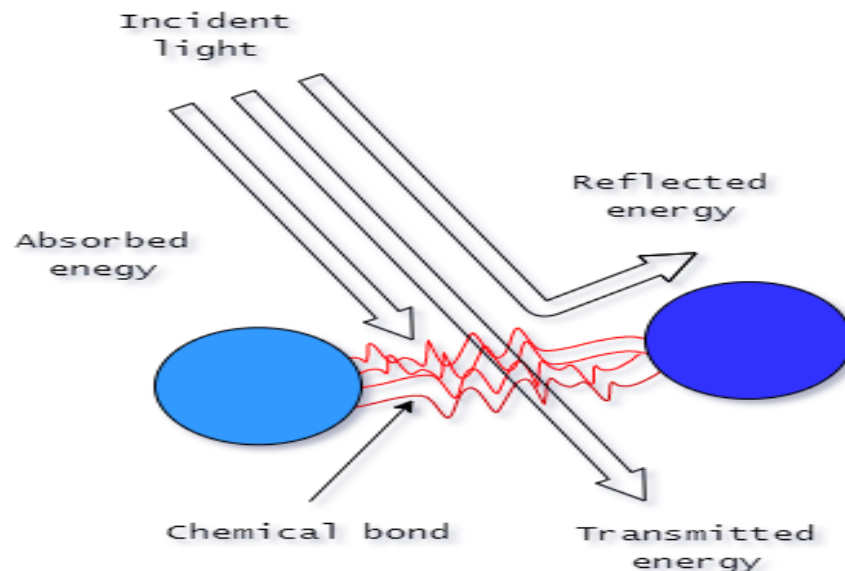

Figure 2.6. Illustration of light energy-sample interaction, principle of infrared spectroscopy (Adapted from Burton et al. 2020)

Detection of soil nutrients using NIR spectroscopy has been toughly researched and is one of the most common methods employed in terms of on-the-go detection of soil nutrients. A great example of NIRS based instrument can be seen in Figure 5 which consists of soil penetrating probes adjoined with soil. Such a device can measure soil nutrients rapidly, on-site, and display results in real-time. NIRS based devices are an ideal tool to measure nitrogen and organic matter content in the soil as absorption peaks of these constituents usually exist at around 850nm and 940nm. The main disadvantage of portable NIR spectrometers is that they require site-specific calibration which can add to the cost of applying such methods. An et al. (2013) developed a total nitrogen detector for soil. The instrument was designed to consist of an optical unit and a control unit, receiving light from the near-infrared LEDs instead of sunlight. Six LEDs of different wavelengths (1550, 1300, 1200, 1100, 1050, and 940 nm) were selected as sensitive wavebands. The detector acquires reflected light from the soil and transfers the optical signal to the photoelectric sensor which converts it to an electrical signal. The developed prototype uses the absorbance data at each wavelength to estimate and calculate soil TN content, simultaneously displaying it on the LCD and storing it on the disk.

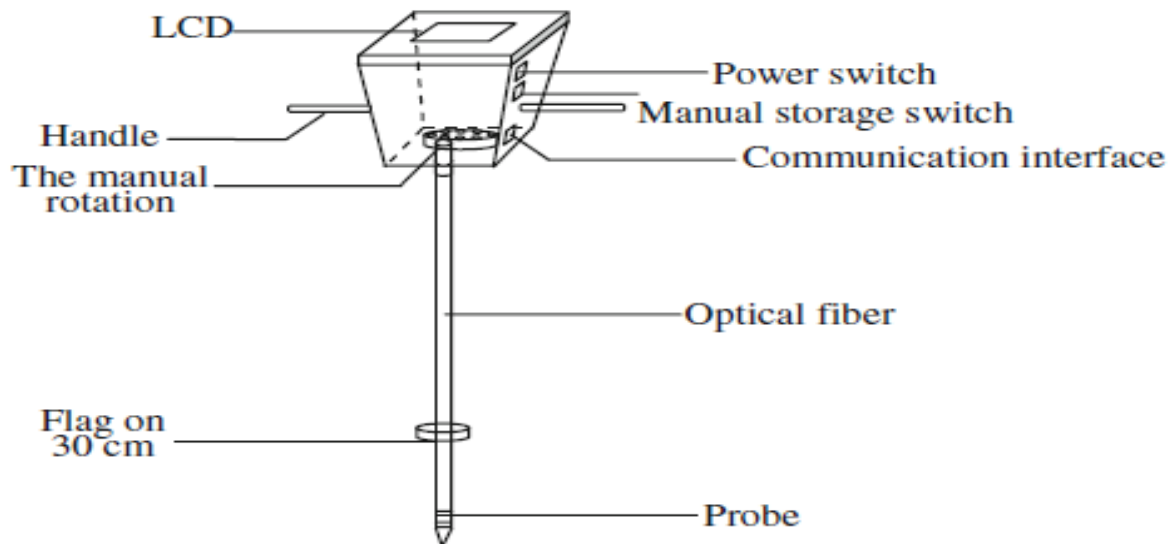

Figure 2.7 Prototype of NIRS based Total Nitrogen detector (Source: An et.al. 2013)

In addition to nutrient detection, NIR spectroscopy was also employed in the assessment and prediction of various other soil and crop properties. Zovko et al. (2018) explored the use of NIR spectroscopy to assess and monitor soil salinity in the floodplains of the Neretva River valley. The main goal of this research was to propose an effective approach based on Vis-NIR and geostatistics for mapping soil salinity. Multivariate geostatistical approaches of soil textural properties were performed in order to describe the variability of soil properties influencing salinity patterns in the researched area. Authors have successfully developed an effective tool for mapping, managing, and preventing further soil salinization by combining geostatistics with NIR spectroscopic analysis. The Paper proposed an accurate and cost-effective method to identify and implement accurate techniques for assessing and monitoring salt-affected soils. The results suggested wide applicability of the method since it accounts for intrinsic variability of the area and is highly scalable.

Spectroscopy is often used to determine several crop parameters that are crucial to agricultural production. For instance, plant tissue has a unique spectral radiance or reflection that changes under the influence of phenological stages, dehydration, or different N nutrition, and thus represents the function of the development phase and plant N content. In situ diffuse visible and near-infrared (VNIR) hyperspectral reflectance spectroscopy to characterize crop optical properties as an early pre-visual indicator of nutrient stress can provide functional data and non-destructive, cost-effective, and rapid quantitative assessment of crop variables. (Sestak et al. 2018). Li et al. (2008) found that a simple ratio vegetation index can be used to estimate N status for winter wheat in over-fertilized farmers' fields before heading using a handheld

spectroradiometer. Šestak et al. (2018a) investigated the ability of Vis-NIR spectroscopy to predict winter wheat grain yield grown under nine mineral nitrogen fertilization treatments. The study proposed prediction methods for in-season estimates of winter wheat yield at a field scale and developed models for in-season N rate optimization. Results provide a basis to further construct a platform for dynamic management of N fertilization

When compared to portable colorimetry based soil analysis methods, on-the-go spectroscopic methods for soil analysis represent more advanced systems. NIR spectroscopy-based methods can't determine potentially bioavailable soil nutrient forms, unlike chemical reagent based methods, which indicate the concentration of mobile nutrient forms. Near-infrared spectroscopy has been found to be a feasible option for implementation in real-time, in-field monitoring scenarios (Isaac 2000). Besides its uses for rapid soil analysis, NIR spectroscopy is used as a tool for mapping different soil properties. The main limiting factor in the assessment of the soil properties is finding certain data pre-treatment and calibration procedures (Mohamed et al. 2018). NIR spectroscopy is the most widely applied spectroscopic technique in agriculture, mainly due to its versatile uses. The method is highly suitable for integration with IoT systems as it offers huge potential when further implemented with AI.

2.3.1 Raman spectroscopy

Raman spectroscopy is a spectroscopy technique based on inelastic scattering of monochromatic lights, unlike other infrared spectroscopic techniques that are based on the absorption of light energy. Raman spectroscopy device measures changes in wavelength and intensity of scattered light upon interaction with a sample. When incident light energy interacts with a sample it becomes absorbed and reemitted from the sample at different frequencies, known as Raman scatter or Raman effect. Shift in the frequency provides information about the sample, as the spectrum of the scattered frequencies indicates the molecular composition. Raman spectroscopy can be used for the characterization and identification of organic and inorganic compounds in soil samples (Luna, 2017). Raman spectroscopy was researched for in-situ soil sensing and has provided the best results in phosphorus detection. Researches Lee and Bogrecki (2007) patented a Raman based spectrometer device capable of measuring nitrogen, potassium, and phosphorus in wet and dry soils, using a laser light source at 785 nm. Their device is a portable sensor for remote, in-situ determination of the presence and concentration of phosphorus, and other soil macronutrients, in real-time. The portable sensor

utilizes Raman spectroscopy technology to detect and/or quantifying soil nutrients such as phosphorus, nitrogen, potassium, potash, magnesium, sulphur, and other trace elements. Soil samples can be provided in a variety of forms including solid or slurry.

The principal advantage proposed for the use of Raman spectroscopy is the minimal sample preparation. In contrast to many other analytical techniques, no chemical or mechanical pre-treatment is necessary (Luna, 2017). Raman spectroscopy is a promising technique for soil monitoring. The integration of Raman based spectrometer devices to IoT system opens the possibility to perform high grid density in situ measurements. However, continuous monitoring of soil nutrients isn't possible due to the limitations of this technique as it requires human interaction.

2.3.2 Fourier Transform Infrared (FTIR) spectroscopy

Fourier Transform Infrared (FTIR) is the preferred method for mid-IR spectroscopy as it provides quantitative information in a rapid and accurate fashion. A typical FTIR spectrometer obtains an infrared spectrum by collecting the interferogram of a sample signal, which contains all the infrared frequencies, applies the Fourier transform (mathematical process) to the digitized signal, and outputs the spectrum (Raphael 2011). The operation of FTIR spectrometer relies on an interferometer, which splits the radiation beam into two beams that are recombined after a path difference has been introduced (Griffiths et al. 1986). The interferometer is located between two perpendicular mirrors, one fixed and one moveable creating path difference between two beams. After the beams return to the beam splitter, they interfere and are again partially transmitted and partially reflected to the detector (Raphael 2011). An interferogram is produced as a function of a path difference due to variations in the energy reaching the detector. The detected interferogram can not be interpreted directly, instead an interferogram signal is decomposed into its component frequencies and amplitudes using Fourier Transformation. The main advantage of using Fourier transform technique is information-rich signals.

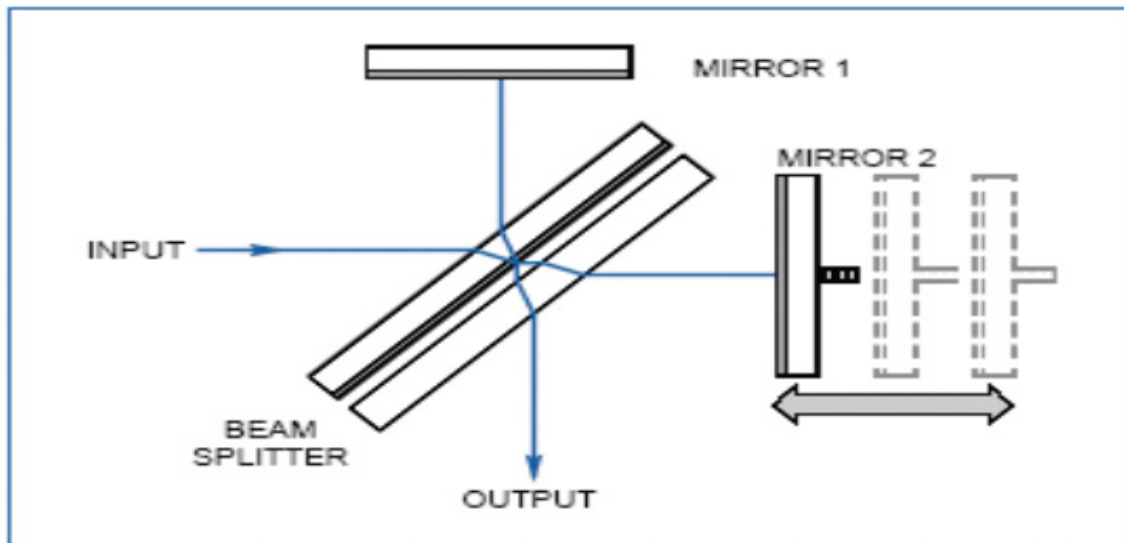

Figure 2.8. Schematic description of interferogram (Adapted from Raphael, 2011.)

Researchers Nyugen et al. (1991), first introduced the use of diffuse reflectance Fourier Transform (DRIFT) spectroscopy for soil analysis to circumvent the drawbacks of transmittance measurements. Subsequent research by Janik and Skjemstad (1995) proved that mid-IR DRIFT technique can be used to quantify various soil components. An extensive review paper by Viscara Rossel et al. (2006) lists studies focused on the determination of N, P, K using different spectroscopic methods reported conflicting results in studies using DRIFT technique. The errors are due to a lack of standards in DRIFT technique itself and analytical reference analyses. However, the potential to implement DRIFT technique in the field remains large and such applications will be possible in the near future as sensing hardware is becoming smaller and more robust. The potential of the technique further rises considering the possibility of integration into an IoT system. Detailed output of DRIFT devices could be enhanced by connecting such devices to a spectral database or library, which could help produce highly detailed models and predict nutrient distribution in the soil.

FTIR spectroscopy was successfully commercialized by NeoSpectra sensors. The full FTIR functionality on a chip-scale is enabled by using Silicon integrated Micro Optical Systems Technology (SiMOST). The use of MEMS technology also makes NeoSpectra sensors highly resistant to shock and vibration compared to alternative solutions employing discrete optics, making these sensors perfect for use in agricultural applications in rugged environments. According to the study conducted by Budiman (2019) tested and predicted soil

organic carbon on 24 soil profiles collected from an agricultural area in New South Wales. Study concluded that results from NeoSpectra sensors were comparable to the high-end laboratory devices and that less costly devices such as the NeoSpectra provide high potential for soil analysis. Most FT-mid-IR instruments today are based on small versions of conventional interferometer designs. To achieve miniaturization while retaining performance conventional Michelson interferometer with discrete components was replaced with monolithic Michelson interferometer chip. NeoSpectra Micro sensor enables almost seamless hardware and software integration into various products, end-use devices, environments, and applications. Given the increasing availability of portable and handheld commercial spectrometers on the market combined with technological advancements in mobile spectroscopy, future developments guarantee to yield full potential to applications of such methods in agriculture.

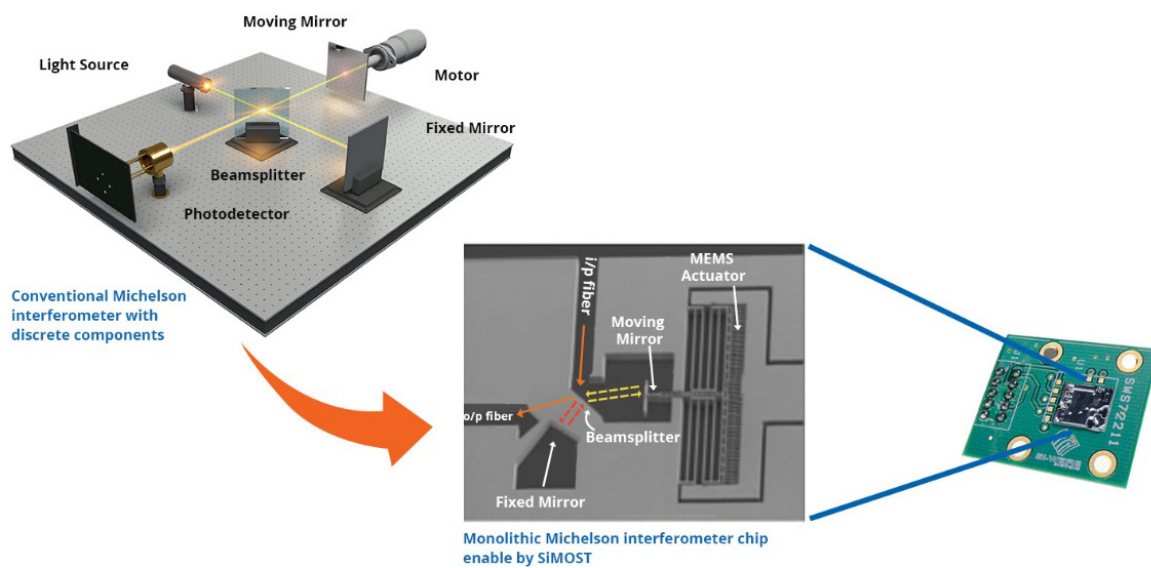

Figure 2.9. Diagram showing MEMS FT-IR spectroscopy (Source: <https://www.neospectra.com/wp-content/uploads/2019/01/diagram-ft-ir.jpg>)

3 Electrochemical sensing methods

Electrochemical methods are becoming increasingly popular due to the miniature size of hardware, long-term field deployability, fast signal response, and cost-effectiveness. Electrochemical sensors have become an attractive approach to monitor soil nutrients in real-time, achieved through the integration of sensors to autonomous systems connected to networks. Electrochemical sensors measure chemical content by coupling a chemically selective layer, also referred to as a membrane to an electrochemical transducer. The transducer converts the chemical energy into an electric signal. Chemical energy is produced when a chemically selective layer is in contact (interacts) with the target ion. The electrical techniques used for the transduction of the ion of interest (target ion) allows electrochemical sensors to be further organized into subcategories. These categories include

- potentiometric, which measures the changes in membrane potential.
- conductometric for measuring changes in conductance.
- impedimetric sensors which measure changes in impedance, and
- amperometric sensors for measuring changes of current at the sensing membrane

The two most commonly used electrochemical sensors to determine soil nutrients are the ion-selective electrodes (ISE) and the ion-selective field-effect transistors (ISFET).

3.1 Ion-selective field-effect transistors (ISFET)

Ion-selective field-effect transistors are simply ISE's joined with a field-effect transistor (FET). There are two types of FET devices, p-type and n-type. The device type dictates which carrier conducts the flow of current (Burton et al. 2020.). The response mechanism of ISFETs is based on their semiconductor nature and on the electrochemical phenomena that occur in the chemically sensitive membrane placed on the gate of the transistor (Artigas, 2001). Materials involved in making gate layers include SiO_2 (Bergveld 1972.), Si_3N_4 (Matsuo and Wise, 1974.) and Al_2O_3 (Abe et al. 1979.).

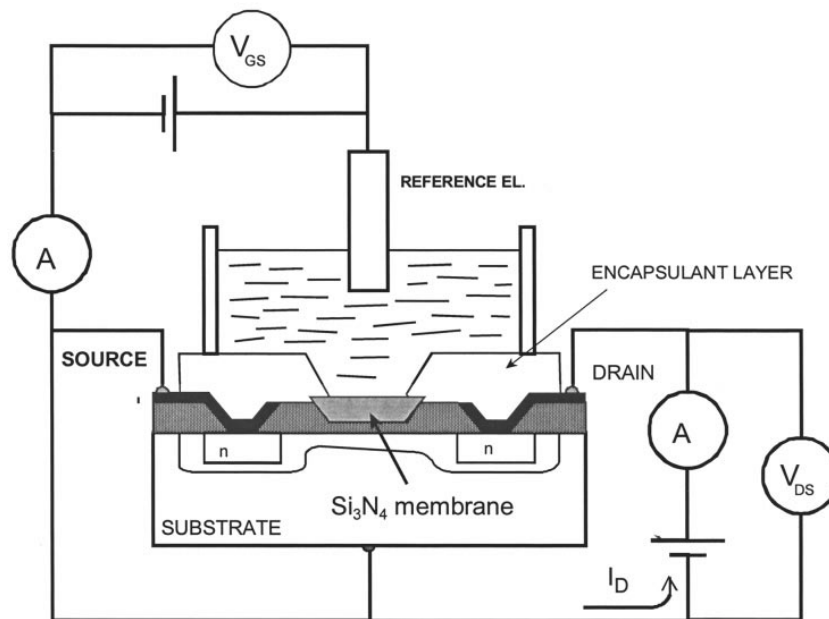

Figure 3.1. Scheme of the n-type ISFET device and response mechanism (Source: Artigas, 2001.)

The presence of ions in the solution shift gate voltage (V_{GS}) resulting in the current shift drain (I_D). The current flowing between the drain and the source of the transistor can be modulated by gate voltage in such a way that the voltage between drain and source (V_{DS}) is amplified.

Artigas et al. (2001) (Figure 3.1.) have proposed an application of ISFETs to measure Ca^{2+} , K^+ , NO^- nutrients, and pH levels in soils. The robust, small size and low output impedance ISFETs had photocurable polymeric selective membranes deposited on transducer fabricated with microelectronic technology. ISFETs response was tested in horticulture soils and compared with standard methods; the results confirmed the feasibility of ISFET sensors for in-soil monitoring. The ISFET's are highly sensitive sensors that can be combined with flow injection analysis (FIA) systems that detect nutrient ions in aqueous solutions. In a paper by Birrell and Hummel (2001.) the use of ISFETs in combination with FIA demonstrated evaluation of nitrate concentration in manually extracted solutions from 14 Illinois surface soils. Price et al. (2003.) have developed a nitrate extraction system that in combination with ISFET technology was used to map soil nitrate on-the-go. Researchers Sudduth et. al. have successfully used ISFET's with FIA to measure soil nutrients from prepared extracts. Flow injection analysis system increases efficiency and helps to offset the ISFET sensor drift. ISFET's are smaller in size and have rapid response time when compared to ISE's. Main disadvantage of ISFET's coupled with the FIA system is a reliance on the extraction system.

3.2 Ion-selective electrodes (ISE)

Ion-selective electrodes are electrochemical ion detection systems made up of conductive material with a specialized membrane/layer (glass/polymer) which selectively responds to target ions. Target ions concentrations are determined by calculating the voltage drops across the membrane using Nernst equation (Burton et al. 2020). The Nernst equation describes the basic mechanism of ISE sensors, and is described as follows:

$$\phi = \phi^0 + \frac{RT}{z_1} F (\ln a_1^{solution}) \quad (3)$$

Where ϕ is the electro potential, ϕ^0 is the standard value of the potential, R is the gas constant, T is the absolute temperature, z_1 is the target ion charge number, F is the Faraday constant, and a_1 is the concentration.

The ion-selective electrode sensor system usually consists of two main parts, two electrodes, one of which is a working electrode detecting specific target ions, and one a reference electrode supplying constant voltage and sensitive layer. ISE's are proven to have a wide dynamic range, appearing to distinguish between variations in concentrations of residual nitrogen (0.1 – 10,000 ppm N) and nutrients. ISE's have also been known to gather rapid measurements in slurries, unfiltered soil extract, and naturally moist soils (Burton et al. 2020.). Researchers have tried various membrane materials for detection and quantification of nutrients in the soil, but most precise detection systems narrowed down the choice to doped polymer electrode membranes for nitrogen detection, valinomycin-bis (2-ethylhexyl) sebacate (DOS) based electrode membranes for detecting potassium, and cobalt rod based for detecting phosphorus. ISE applied in direct soil measurement (DSM) provide fast and accurate way to measure soil nitrates. Ali et al. (2020.), developed a deployable electrochemical soil nitrate sensor using a nanocomposite of molybdenum disulphide (MoS₂) and poly(3-octyl-thiophene) coated on a printed circuit board. The ion-selective membrane was capable of detecting nitrate-nitrogen in soil slurries and was highly sensitive in ranges of 1ppm - 1500 ppm.

Unlike spectroscopic methods, electrochemical sensing does not require optical complex setup and can be deployed directly in soil for nutrients measurements (Ali et al. 2020.). On-site measurement has been explored by Adamchuk et al. (2002., 2004., 2005.), by developing an automated on-the-go monitoring system for soil nitrate-nitrogen (NO³-N) using ion-selective electrodes. Kim et al. (2007.) have tested the ability of ISE's to simultaneously

detect K and N in soil samples from Missouri and Illinois. Electrochemical sensing techniques are increasingly being combined with IoT systems. There are still many issues to overcome in order to commercialize aspects of these technologies. While these ion-selective systems have shown the feasibility of making rapid measurements on soil extractant mixtures, the fragility of the ion-selective membranes used has caused significant problems with the robustness and reproducibility of soil measurements. Ion-selective systems also require frequent calibration, making them unappealing for routine field use.

4 Internet of Things applications in real-time soil monitoring

The common definition describes IoT as a system of embedded technologies consisting of wired and wireless communications, sensors, and actuators that are capable of acquiring and transferring data to the internet. IoT is having an increasing role in various applications of agriculture as new smart farming technologies are implemented in different aspects of the industry. Existing communication technologies (Table 4.1.) such as SMS, Bluetooth, Wi-Fi, ZigBee, LoRa, and SigFox enable interaction between sensors and soil. The framework structure of the IoT system consists of three parts: object end (front end), network end (communication infrastructure), and cloud end (back end). Sensors and actuators that interact directly with the physical world form the object end of an IoT system. The communication infrastructure which connects object end devices to the cloud forms the network end. The cloud computing platform that processes and analyses sensing data received from the object end and provides storage, computing, and other resources constitutes the cloud end of the IoT system. A unique identifier tag is assigned to each device and/or object (sensor) which provides the ability to receive and transmit the signal over the network. According to the different functions implemented by physical entity services in the IoT, IoT architecture established by the current service-oriented approach can be divided into the following two categories: cloud-centric IoT architecture and object-centric IoT architecture. In the cloud-centric IoT application system, the physical entity service implements basic physical information collection, local information processing and transmission of information to the cloud, but does not provide a directly accessible service interface. Mass storage, relational processing, and knowledge mining of physical information are all implemented in the cloud (Shi et al. 2019.). The data acquired through the wireless sensors cannot be transmitted in the absence of reliable communication infrastructure (Ayaz et al. 2019.). The major challenge limiting the introduction and growth of IoT in the agriculture industry is the lack of communication infrastructure and related facilities (base stations, WiFi access points).

Table 4.1. Summary of wireless communication technologies used in IoT (Source: Shi et al. 2019.)

Wireless Technology	Wireless Standard	Network Type	Transmission Range
Wi-Fi	IEEE802.11 a/c/b/d/g/n	WLAN	20–100 m
Bluetooth	Bluetooth (Formerly IEEE 802.15.1)	WPAN	10-300m
6LowPAN	IEEE 802.15.4	WPAN	20-100m
Sigfox	Sigfox	LPWAN	<50km
LoRaWAN	LoRaWAN	LPWAN	<15km
NB-IoT	3GPP	LPWAN	<15km
Mobile cellular technology	2G-GSM, GPRS 3G-UMTS CDMA2000 4G-LTE	GERAN	Entire cellular area
ZigBee	IEEE 802.1	Mesh	0-10m
NFC	ISO/IEC 131575.4	Point to Point	0.1m

Considering the requirements of an IoT system capable of soil nutrient detection and monitoring, the proposed general structure consists of five-layer architecture. These layers are: 1) Perception layer, 2) Network layer, 3) Middleware layer, 4) Common platform layer, and the 5) Application layer. Figure 4.1. shows the components that make up each layer.

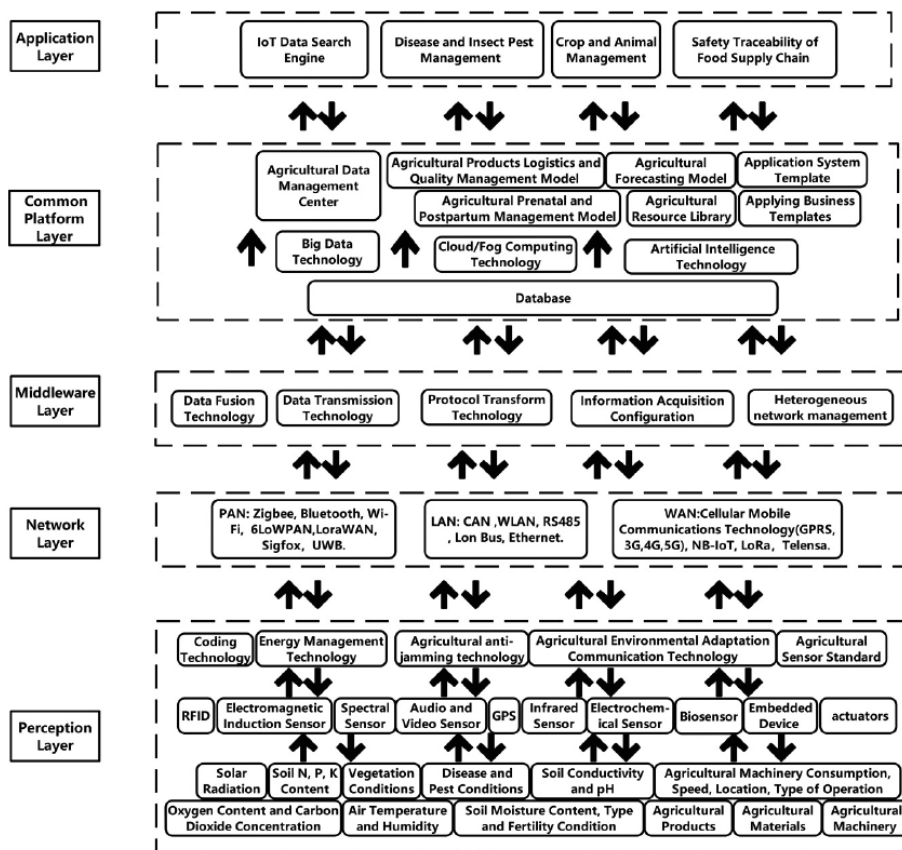

Figure 4.1. General structure of IoT system in agriculture (Source: Ge et al. 2014.)

The context of IoT in soil monitoring can be described with the term wireless sensor network since monitoring requires the use of multiple sensors. A wireless sensor network is specifically composed of multiple autonomous, small size, low cost, low power, and multifunctional sensor nodes. By carefully engineering the communication topology, a sensor node can communicate with others or a base station based on a routing structure (Ngyuen et al. 2016.). Sensor nodes usually consist of a sensor interface board that can be equipped with various types of sensors to measure soil temperature, moisture content and chemical (pH, salinity) properties. Implementing sensors on-site in a specific location enables continuous monitoring of soil parameters. Soil nutrients can be measured and continually monitored by either electrochemical (ISE, ISFET) or optical (soil probe) sensors. A paper by Galande et al. (2015.) presented the integration of NPK sensors with a wireless sensor network. Sensor nodes sent data via a wireless connection to the central server which also stored, collected, and processed the data for the display to the desired output. The central server is also referred to as the base station. A real-time in situ IoT soil sensor system can be fully automated to monitor soil nutrients without human interaction. In a review paper researchers, Burton et al. (2020.) proposed a decision support system (Figure 4.2.) for site-specific nutrient management that includes a deployable sensor system capable of acquiring real-time data of soil nutrient conditions. The proposed sensor system forwards the acquired data to a gateway node where the data can be logged or transmitted to a cloud for further analysis using machine learning and neural networks. A decision support system predicts soil nutrient requirements and helps in fertilizer application to prevent nutrient overload. IoT in digital farming.

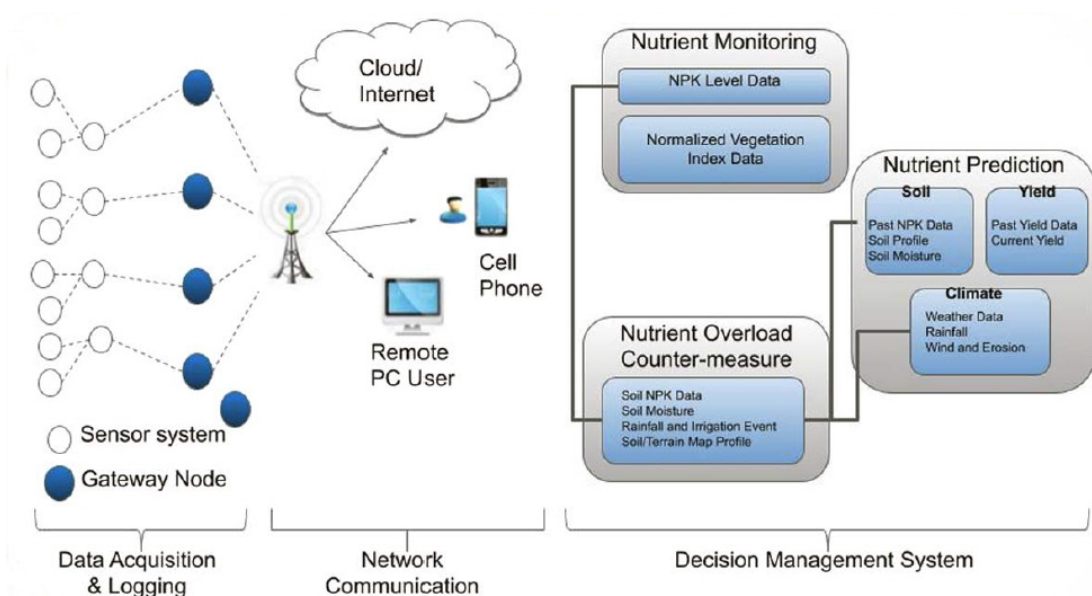

Figure 4.2. Schematic of a decision management system for nutrient fertilizers (Source: Burton et al. 2020.)

4.1 IoT in digital farming

Digital farming is synonymous with the term smart farming, which is part of the precision agriculture concept. Interfacing farms with IoT, WSN, and AI technologies significantly improve all operations related to agricultural production. Considering this scenario, future agriculture is expected to evolve as a high-tech industry where interconnected systems will enjoy the luxury of artificial intelligence and Big Data facilities. By involving advanced technologies like agricultural robots, Big Data, and cloud-computing artificial intelligence, agriculture can create a new era of superfusion (Ayaz et al. 2019.). Popular IoT applications in digital farming-based applications are in greenhouses, and vertical farming integrated with emerging practices of aquaponics, aeroponics, and hydroponics (Benke et al. 2017.). The use of WSN and IoT for digital farming was demonstrated in a paper by Mekonnen et al. (2018.) in which a smart farming prototype (Figure 4.3.) was developed. The prototype used sensor data to predict crop yield, reduce resource consumption, and raise the productivity of the experimental testbed. The prototype implemented an IoT based data-driven sensor system implemented with machine learning algorithms for data mining and forecasting to help boost agricultural productivity. The overall system was designed to be power-efficient, cost-effective, and low maintenance, allowing the farmers/users to manage their farm or garden with little to no effort. Capabilities offered by IoT, including the basic communication infrastructure (used to connect the smart objects from sensors, vehicles, to user mobile devices using the Internet) and range of services, such as local or remote data acquisition, cloud-based intelligent information analysis, and decision making, user interfacing, and agriculture operation automation can revolutionize the agriculture industry which probably one of most inefficient sectors of our economic value chain today (Ayaz et al. 2019.).

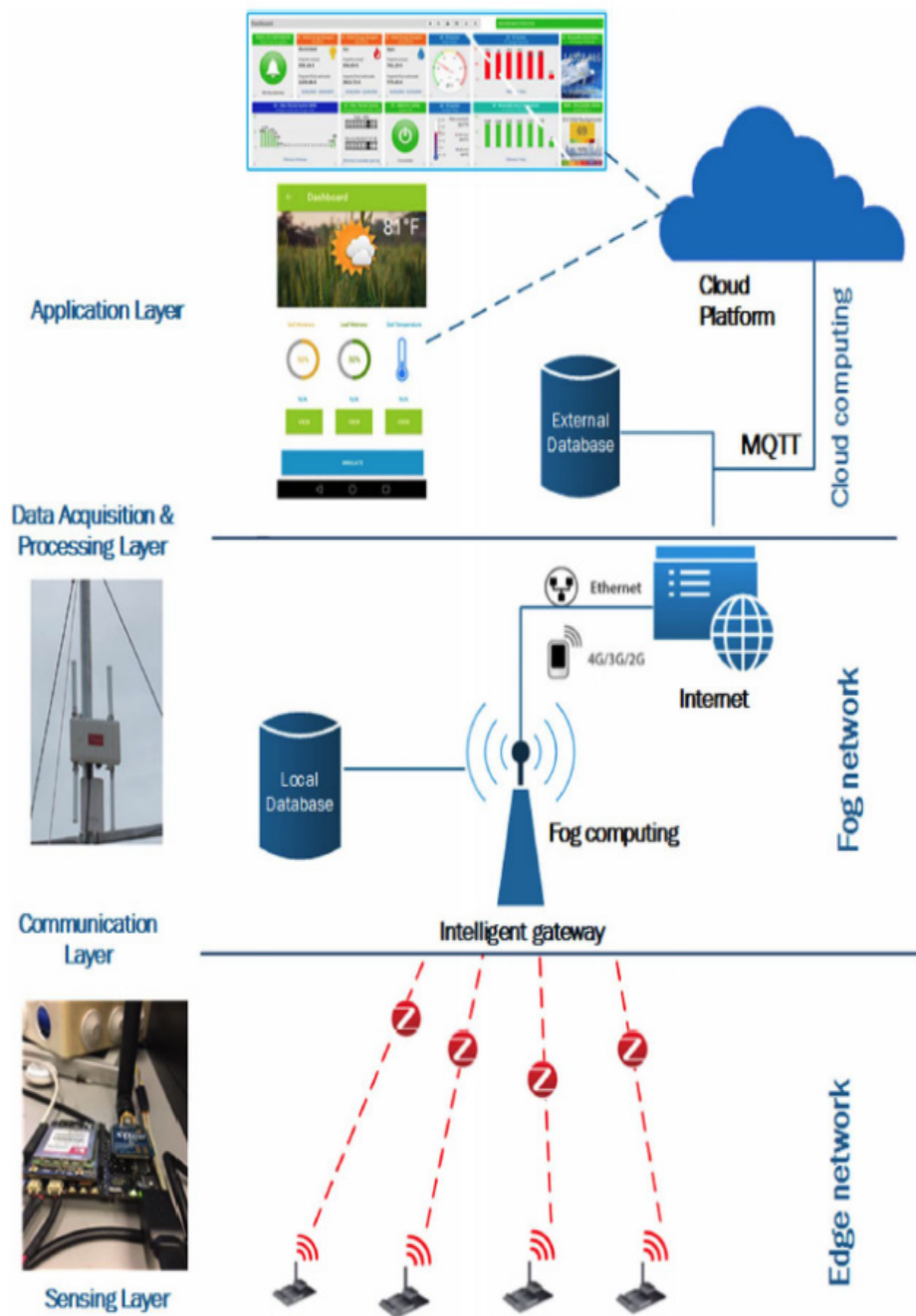

Figure 4.3. Smart farm prototype IoT architecture scheme (Source: Mekonnen et al. 2020)

4.2 Artificial Intelligence (AI) applications in soil monitoring

Artificial intelligence (AI) can help farmers get more from the land while using resources more sustainably (Mekonnen et al. 2020.). With the emergence of blockchain, AI, and Big data agriculture is being transformed into a more sustainable industry. Big data refers to the large volume of data coming from sensors, IoT, GPS, aerial imagery, etc (Mekonnen et al. 2020., Wolfert et al. 2017.). Today's farmers can benefit from the AI as they can gain real-time data insight into different soil conditions. Incorporating various soil assessment methods with IoT and AI offers enables farmers real-time monitoring helping them minimize resource utilization and optimize production costs. Machine learning techniques used by AI ensure farmers make better and informed decisions based on sensor data more quickly when it comes to real-world scenarios. Machine learning is a type of AI that gives machines the ability to learn from experience. Its algorithms (Figure 4.4.) use computational methods to learn directly from datasets without depending on predetermined equations as a model. The algorithms progressively adapt to enhance their performance as the available number of training samples increases (Barber 2012., Bishop 2006., Murhpy 2012., Mekonnen et al. 2020.). By applying ML to sensor data, farm management systems are evolving into real AI systems. Advances in ML and analytics have given farmers data mining possibilities, providing them with accurate trend predictions. AI must be leveraged to increase the automation of tasks in agriculture and improve the yield while optimizing the use of natural resources. (Mekonnen et al. 2019.). In a paper by Laili et al. (2020.) NIR spectroscopy was used in combination with the Microsoft Azure Machine Learning platform (AML) to predict soil organic matter. The analyzed dataset consisted of 108 soil spectral samples which were used to develop a calibration (classification) model using Decision forest, Decision jungle, Logistic regression, and neural network algorithms. The prediction model was developed with the help of Bayesian linear, boosted decision tree, decision tree, and linear regression algorithms. Results indicated an excellent prediction performance of SOM due to the ability of the ML algorithms to reduce spectrometer signal noise. Authors also suggested further development of the method by using mobile spectrometers with Bluetooth connectivity to fully integrate

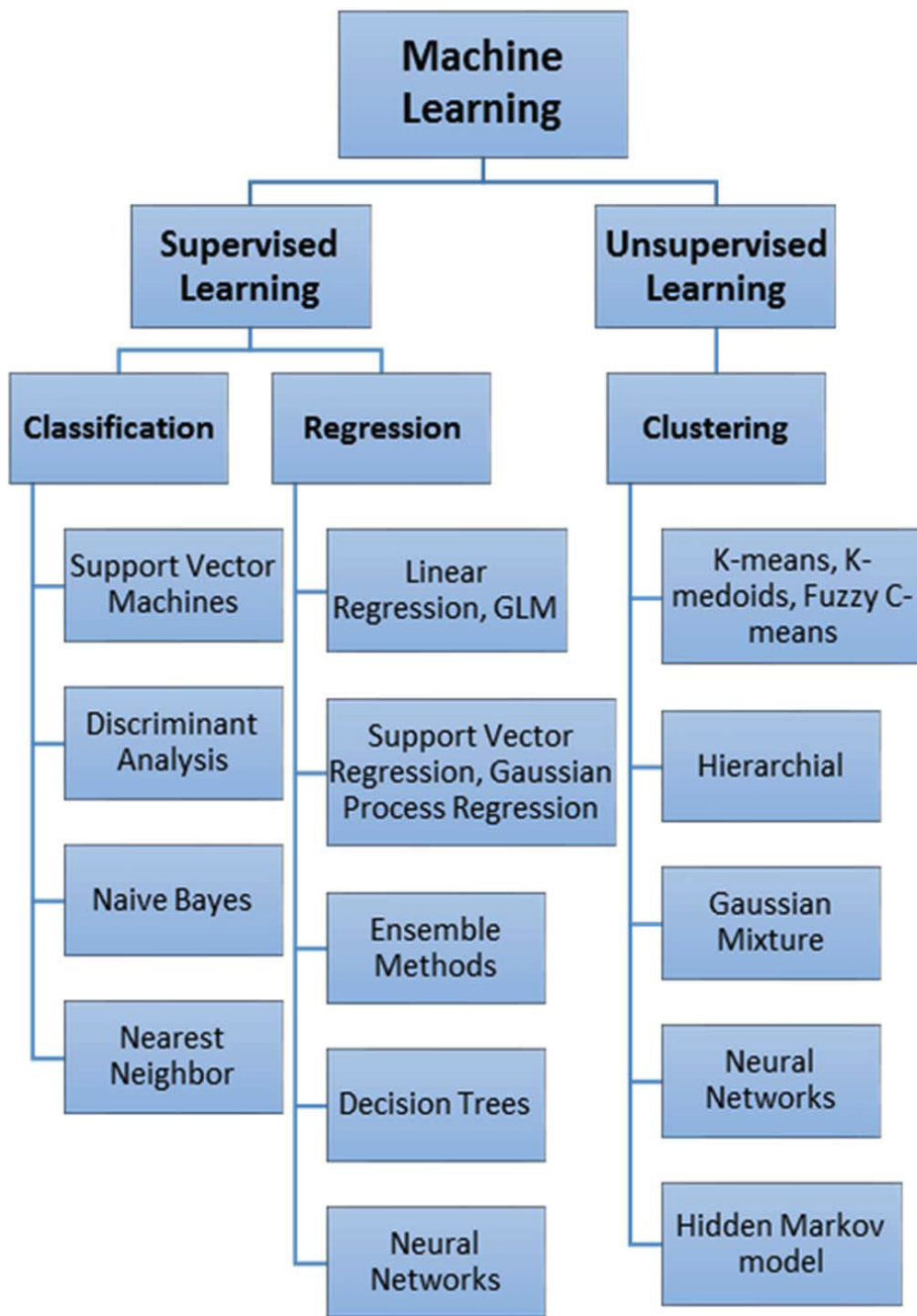

Figure 4.4. Overview of machine learning algorithms (Source: Mekonnen et al. 2020.)

5 General overview of soil monitoring technologies

The soil is a peculiar and complex system to study, even harder to describe using a single definition. The soil has properties that change rapidly within a few hours or days. In figurative terms, this is called the “soil-moment ”(Lvova and Nadporozhskaya 2017.). Proper management of soil fertility is a crucial aspect of precision agriculture. All of the reviewed technologies represent a promising alternative to conventional soil analysis methods, offering fast, accurate and low-cost means to assess and monitor a wide range of soil parameters in real-time.

Considering the possibility of the sensor's ability to perform simultaneous measurements of several soil properties, a multisensory approach seems like the most logical choice. The use of both optical and electrochemical methods in combination with chemometric techniques integrated with IoT facilitates continuous on-site data acquisition. By creating a data-driven sensor system that collects, monitors, and analyses various sensors, ML algorithms can be implemented to further extract valuable information. The integration of AI also increases the automation of tasks related to agriculture and optimizes the use of resources while improving the yield. By making decisions about fertilizer applications based on current (analyzed) soil conditions and historical data (if available) farmers will be able to efficiently manage fertilizer consumption without additional cost. The proposed system would also try to perfectly tailor fertilization guidelines for the farmer by providing information on optimal time, rate, and dosage of fertilizer. The site-specific and user-tailored fertilizing approach helps to estimate the spatial patterns of nutrients requirements with higher accuracy and minimum labor requirements.

6 Conclusion

Technological advancements in the 21st century opened an unimaginable set of possibilities in agriculture. As technology progresses further, agriculture is slowly transformed into a digital industry. Technology plays a central role in mitigating the pressure the farming industry faces due to factors in the rising population, consumer needs, and the growing shortages of land, water, and energy. The use of sensors and the Internet of Things (IoT) is key to moving the world's agriculture to a more productive and sustainable path. (Mekonnen et al. 2020).

Wireless sensor networks and Information and Communication technologies have great potential to address the main environmental, economic, and socio-economic challenges in the agricultural sector. To reach the full potential of precision agriculture and related technologies much more research is required. For universities and research institutes, cloud-based agricultural intelligent decision-making models, multi-source data-based information fusion algorithms, agricultural Big Data mining technologies, distributed intelligent processing systems, and lightweight IoT authentication, encryption, and authorization mechanisms will be the key research directions for the future (Shi et al. 2019.). Future prospects of agriculture have the potential to solve all current problems facing global food production. Finally, the huge positive impacts of technology on agriculture and the environment should be emphasized as technology is playing an increasingly important role in food production and sustainable development of agriculture.

7 References

- 1) Ali Md. A. Dong, L. Dhau, J. Khosla, A. & Kaushik A. (2020). Perspective— Electrochemical Sensors for Soil Quality Assessment. *Journal of The Electrochemical Society*. 167(3) 037550. <https://doi.org/10.1149/1945-7111/ab69fe>
- 2) Amirul M. S., Endut R., Rashidi C. B. M., Aljunid S. A., Ali N., Laili M. H., Laili A. R., Ismail M. N. M. (2020). Nitrate (NO_3^-) prediction in soil analysis using near-infrared (NIR) spectroscopy. 020043. <https://doi.org/10.1063/1.5142135>
- 3) An X., Li M., Zheng L., Liu Y., & Sun H. (2014). A portable soil nitrogen detector based on NIRS. *Precision Agriculture* 15(1), 3–16. <https://doi.org/10.1007/s11119-012-9302-5>
- 4) Angelopoulou T. Balafoutis A. Zalidis G., & Bochtis D. (2020). From Laboratory to Proximal Sensing Spectroscopy for Soil Organic Carbon Estimation—A Review. *Sustainability* 12(2), 443. <https://doi.org/10.3390/su12020443>
- 5) Artigas J., Beltran A., Jiménez C., Baldi A., Mas R., Domínguez C., & Alonso J. (2001). Application of ion sensitive field effect transistor based sensors to soil analysis. *Computers and Electronics in Agriculture* 31(3), 281–293. [https://doi.org/10.1016/S0168-1699\(00\)00187-3](https://doi.org/10.1016/S0168-1699(00)00187-3)
- 6) Ayaz M., Ammad-Uddin M., Sharif Z., Mansour A., & Aggoune E.-H. M. (2019). Internet-of-Things (IoT)-Based Smart Agriculture: Toward Making the Fields Talk. *IEEE Access* 7, 129551–129583. <https://doi.org/10.1109/ACCESS.2019.2932609>
- 7) Bhatnagar V., Poonia R. C. (2018). A prototype model for decision support system of NPK fertilization. *Journal of Statistics and Management Systems*, 21(4) 631–638. <https://doi.org/10.1080/09720510.2018.1471266>
- 8) Burton L., Jayachandran K., Bhansali S. (2020). Review—The “Real-Time” Revolution for In situ Soil Nutrient Sensing. *Journal of The Electrochemical Society* 167(3), 037569. <https://doi.org/10.1149/1945-7111/ab6f5d>
- 9) Chowdhury M. E. H., Hossain B., Adhikary T., Rahman M. T., & Razzaque A. (n.d.). *Remote Analysis of Soil Macronutrients Using Optical Sensor for Precision Agriculture*. 13.
- 10) Curcio D., Ciraolo G., D’Asaro F., & Minacapilli M. (2013). Prediction of Soil Texture Distributions Using VNIR-SWIR Reflectance Spectroscopy. *Procedia Environmental Sciences* 19, 494–503. <https://doi.org/10.1016/j.proenv.2013.06.056>

- 11) Dimkpa C. Bindraban, P. McLean, J. E. Gatere, L. Singh U., & Hellums D. (2017). Methods for Rapid Testing of Plant and Soil Nutrients. In E. Lichtfouse (Ed.) *Sustainable Agriculture Reviews* Vol. 25, 1–43. Springer International Publishing. https://doi.org/10.1007/978-3-319-58679-3_1
- 12) Lavanya G., Rani C., Ganeshkumar P. (2019). An automated low cost IoT based Fertilizer Intimation System for smart agriculture. *Sustainable Computing: Informatics and Systems* S2210537918302567. <https://doi.org/10.1016/j.suscom.2019.01.002>
- 13) Ge Y., Morgan C. L. S., Wijewardane N. K. (2019). Visible and Near-Infrared Reflectance Spectroscopy Analysis of Soils. *Methods of Soil Analysis* 4(1), 0. <https://doi.org/10.2136/msa2017.0040>
- 14) I. Bogrecki, W. S. Lee. (2006). EFFECTS OF SOIL MOISTURE CONTENT ON ABSORBANCE SPECTRA OF SANDY SOILS IN SENSING PHOSPHORUS CONCENTRATIONS USING UV-VIS-NIR SPECTROSCOPY. *Transactions of the ASABE*. 49(4) 1175–1180. <https://doi.org/10.13031/2013.21717>
- 15) Isaac W., Na A. (2016). On-the-go soil nitrogen sensor based on near infrared spectroscopy. *2016 International Conference on Information Technology (InCITE) - The Next Generation IT Summit on the Theme - Internet of Things: Connect Your Worlds*. 312–315. <https://doi.org/10.1109/INCITE.2016.7857637>
- 16) Šestak I., Mesić M., Zgorelec Ž., Perčin A., Stupnišek I., (2018). Visible and near infrared reflectance spectroscopy for field-scale assessment of Stagnosols properties. *Plant Soil and Environment*, 64(6) 276–282. <https://doi.org/10.17221/220/2018-PSE>
- 17) Johnson J.M., Vandamme E., Senthilkumar K., Sila A., Shepherd K. D., Saito K. (2019). Near-infrared mid-infrared or combined diffuse reflectance spectroscopy for assessing soil fertility in rice fields in sub-Saharan Africa. *Geoderma* 354, 113840. <https://doi.org/10.1016/j.geoderma.2019.06.043>
- 18) Kapse S., Kale S., Bhongade S., Sangamnerkar S. (2020). *IOT Enable Soil Testing NPK Nutrient Detection*. 9.
- 19) Karim F., Karim F., Frihida A. (2017). Monitoring system using web of things in precision agriculture. *Procedia Computer Science* 110, 402–409. <https://doi.org/10.1016/j.procs.2017.06.083>
- 20) Laili A. R., Endut R., Ali N., Laili M. H., Amirul M. S., Aljunid S. A., Rashidi C. B. M., Ismail M. N. M. (2020). *Prediction of soil macronutrient (nitrate and*

- phosphorus*) using near-infrared (NIR) spectroscopy and machine learning. 020061. <https://doi.org/10.1063/1.5142153>
- 21) Laskar S., Mukherjee S. (2016). Optical Sensing Methods for Assessment of Soil Macro- nutrients and other Properties for Application in Precision Agriculture: A review. *Journal of Engineering Technology* 4, 5.
- 22) Lourembam D., Laskar S., Mukherjee S. (2018). Framework for an optical sensor system for monitoring of soil nitrogen and tailoring soil pH. *Journal of Optics* 47(2), 180–194. <https://doi.org/10.1007/s12596-017-0434-x>
- 23) Luna A. S. (2017). Raman Spectroscopy Soil Analysis Applications. In *Encyclopedia of Spectroscopy and Spectrometry* 919–923. Elsevier. <https://doi.org/10.1016/B978-0-12-409547-2.12171-7>
- 24) Lvova L., Nadporozhskaya M. (2017). Chemical sensors for soil analysis: Principles and applications. In *New Pesticides and Soil Sensors* 637–678. Elsevier. <https://doi.org/10.1016/B978-0-12-804299-1.00018-7>
- 25) Madhura U., Akshay P., Bhattad A. J., Nagaraja G. (2017). Soil Quality Management Using Wireless Sensor Network. *2017 2nd International Conference on Computational Systems and Information Technology for Sustainable Solution (CSITSS)* 1–5. <https://doi.org/10.1109/CSITSS.2017.8447860>
- 26) Masrie M., Rosli A. Z. M., Sam R., Janin Z., Nordin M. K. (2018). Integrated optical sensor for NPK Nutrient of Soil detection. *2018 IEEE 5th International Conference on Smart Instrumentation Measurement and Application (ICSIMA)*, 1–4. <https://doi.org/10.1109/ICSIMA.2018.8688794>
- 27) Mekonnen Y., Namuduri S., Burton L., Sarwat A., Bhansali S. (2020). Review— Machine Learning Techniques in Wireless Sensor Network Based Precision Agriculture. *Journal of The Electrochemical Society* 167(3), 037522. <https://doi.org/10.1149/2.0222003JES>
- 28) Mohamed E. S., Saleh A. M., Belal A. B., Gad A. (2018). Application of near-infrared reflectance for quantitative assessment of soil properties. *The Egyptian Journal of Remote Sensing and Space Science* 21(1), 1–14. <https://doi.org/10.1016/j.ejrs.2017.02.001>
- 29) More A., Mouria A., Panchal N., Bathe K. (2019). Soil Analysis Using Iot. *SSRN Electronic Journal*. <https://doi.org/10.2139/ssrn.3366756>
- 30) Nguyen L., Kodagoda S. (2016). Soil organic matter estimation in precision agriculture using wireless sensor networks. *2016 14th International Conference on*

Control Automation, Robotics and Vision (ICARCV), 1–6.

<https://doi.org/10.1109/ICARCV.2016.7838635>

- 31) Peets S., Mouazen A. M., Blackburn K., Kuang B., Wiebensohn J. (2012). Methods and procedures for automatic collection and management of data acquired from on-the-go sensors with application to on-the-go soil sensors. *Computers and Electronics in Agriculture* 81, 104–112. <https://doi.org/10.1016/j.compag.2011.11.011>
- 32) Peng Y., Zhao L., Hu Y., Wang G., Wang L., Liu Z. (2019). Prediction of Soil Nutrient Contents Using Visible and Near-Infrared Reflectance Spectroscopy. *ISPRS International Journal of Geo-Information* 8(10), 437. <https://doi.org/10.3390/ijgi8100437>
- 33) Perdana D., Putra R., Bisono G. (2019). Analysis of Soil Substance Measurement System Based on Internet of Things (IoT) with Star Topology Network. *International Journal of Simulation: Systems Science & Technology*. <https://doi.org/10.5013/IJSSST.a.20.06.03>
- 34) Raphael L. (2011). Application of FTIR Spectroscopy to Agricultural Soils Analysis. In G. Nikolic (Ed.), *Fourier Transforms—New Analytical Approaches and FTIR Strategies*. InTech. <https://doi.org/10.5772/15732>
- 35) Sahni R. K., Kumar D., Tiwari P. S., Kumar V., Kumar S. P., Chandel N. S. (2018). *A DGPS Based on-the-go Soil Nutrient Mapping System: A Review*. 6.
- 36) Sanderman J., Savage K., Dangal S. R. S. (2020). Mid-infrared spectroscopy for prediction of soil health indicators in the United States. *Soil Science Society of America Journal* 84(1), 251–261. <https://doi.org/10.1002/saj2.20009>
- 37) Saravanan P., Zakirah P. A. A., Poojitha B., Kavya S. (2019). A Modern Methodology Enabling Smart Agricultural System. *Journal of Physics: Conference Series* 1362, 012002. <https://doi.org/10.1088/1742-6596/1362/1/012002>
- 38) Šestak I., Mesić M., Zgorelec Ž., Perčin A. (2018). Diffuse reflectance spectroscopy for field scale assessment of winter wheat yield. *Environmental Earth Sciences* 77(13), 506. <https://doi.org/10.1007/s12665-018-7686-x>
- 39) Namuduri S., Narayanan B., Salini V., Davuluru P., Burton L., Bhansali S. (2020). Review - Deep Learning Methods for Sensor Based Predictive Maintenance and Future Perspectives for Electrochemical Sensors. *Journal of The Electrochemical Society* 167(3), 037552. <https://doi.org/10.1149/1945-7111/ab67a8>
- 40) Seybold C. A., Ferguson R., Wysocki D., Bailey S., Anderson J., Nester B., Schoeneberger P., Wills S., Libohova Z., Hoover D., Thomas P. (2019). Application

- of Mid-Infrared Spectroscopy in Soil Survey. *Soil Science Society of America Journal* 83(6), 1746–1759. <https://doi.org/10.2136/sssaj2019.06.0205>
- 41) Shi X., An X., Zhao Q., Liu H., Xia L., Sun X., & Guo Y. (2019). State-of-the-Art Internet of Things in Protected Agriculture. *Sensors*, 19(8) 1833. <https://doi.org/10.3390/s19081833>
- 42) Sinfield, J. V. Fagerman, D. Colic O. (2010). Evaluation of sensing technologies for on-the-go detection of macro-nutrients in cultivated soils. *Computers and Electronics in Agriculture* 70(1), 1–18. <https://doi.org/10.1016/j.compag.2009.09.017>
- 43) Tolentino E. V. N., Andaya V. S., Cristobal G. A. G., Ongtengco R. S., Rosal A. A., Ruzol E. B., Sacramento J. C. A. (2020). Development of wireless data acquisition system for soil monitoring. *IOP Conference Series: Earth and Environmental Science* 463, 012088. <https://doi.org/10.1088/1755-1315/463/1/012088>
- 44) Viscarra Rossel R. A., Behrens T., Ben-Dor E., Brown D. J., Demattê J. A. M., Shepherd K. D., Shi Z., Stenberg B., Stevens A., Adamchuk V., Aichi H., Barthès B. G., Bartholomeus H. M., Bayer A. D., Bernoux M., Böttcher K., Brodský L., Du C. W., Chappell A., Ji W. (2016). A global spectral library to characterize the world's soil. *Earth-Science Reviews* 155, 198–230. <https://doi.org/10.1016/j.earscirev.2016.01.012>
- 45) Yunus Y., Devianti Satriyo P., Munawar A. A. (2019). Rapid Prediction of Soil Quality Indices Using Near Infrared Spectroscopy. *IOP Conference Series: Earth and Environmental Science* 365, 012043. <https://doi.org/10.1088/1755-1315/365/1/012043>
- 46) Zovko M., Romić D., Colombo C., Di Iorio E., Romić M., Buttafuoco G., Castrignanò A. (2018). A geostatistical Vis-NIR spectroscopy index to assess the incipient soil salinization in the Neretva River valley Croatia. *Geoderma*, 332, 60–72. <https://doi.org/10.1016/j.geoderma.2018.07.005>
- 47) Čoga L., Slunjski S. (2018.). Dijagnostika tla u ishrani bilja. Sveučilište u Zagrebu Agronomski fakultet. Zagreb
- 48) Anzalone G., Glover G. A., Pearce J. (2013). Open-Source Colorimeter. *Sensors*. 13(4), 5338-5346 <https://doi.org/10.3390/s130405338>
- 49) Pearce J., Gwamuri J. (2017). Open source 3D printers: an appropriate technology for building low cost optics labs for the developing communities. 14th Conference on Education and Training in Optics and Photonics: ETOP 2017. 187 <https://doi.org/10.1117/12.2269852>

- 50) Stenberg B., Viscarra Rossel R. A., Mouazen A. M., Wetterlind J. (2010). Visible and Near Infrared Spectroscopy in Soil Science. In *Advances in Agronomy* Vol. 107, 163–215. Elsevier. [https://doi.org/10.1016/S0065-2113\(10\)07005-7](https://doi.org/10.1016/S0065-2113(10)07005-7)
- 51) Nocita, M., Stevens, A., van Wesemael, B., Aitkenhead, M., Bachmann, M., Barthès, B., Ben Dor, E., Brown, D. J., Clairotte, M., Csorba, A., Dardenne, P., Demattê, J. A. M., Genot, V., Guerrero, C., Knadel, M., Montanarella, L., Noon, C., Ramirez-Lopez, L., Robertson, J. Wetterlind, J. (2015). Soil Spectroscopy: An Alternative to Wet Chemistry for Soil Monitoring. In *Advances in Agronomy* Vol. 132, 139–159. Elsevier. <https://doi.org/10.1016/bs.agron.2015.02.002>
- 52) Khairunnisa M. Y, Suhaila I., Hafizah N. N., Nurfatihah R. C. A. (2016). LED Based Soil Spectroscopy. *Buletin Optik* (3), 1-7
- 53) Kumar A., Kumar A., De A., Shekhar S., Singh R. K. (2019). IoT Based Farming Recommendation System Using Soil Nutrient and Environmental Condition Detection. *International Journal of Innovative Technology and Exploring Engineering* 8(11), 3055-3060. <https://doi.org/10.35940/ijitee.K2335.0981119>
- 54) Lau K.T., Baldwin S., Shepherd R.L., Dietz P.H., Yezunis W.S., Diamond D. (2003). Novel fused-LEDs devices as optical sensors for colorimetric analysis. *Talanta*, xxx–xxx.
- 55) Khairunnisa M. Y, Suhaila I., Nurfatihah, Nor H. N. (2016). NPK DETECTION SPECTROSCOPY ON NON-AGRICULTURE SOIL. *Jurnal Teknologi (Sciences & Engineering)*. 78(11), 227-231.

Web sources

- 1) <http://www.lusterleaf.com/img/2020catalog/LusterLeaf2020Catalog.pdf>
Accessed – 15.06.2020.
- 2) <https://www.neospectra.com/whats-possible/smart-farming/>
Accessed – 30.07.2020.
- 3) <https://imagine.gsfc.nasa.gov/science/toolbox/emspectrum1.html>
Accessed – 21.06.2020.